

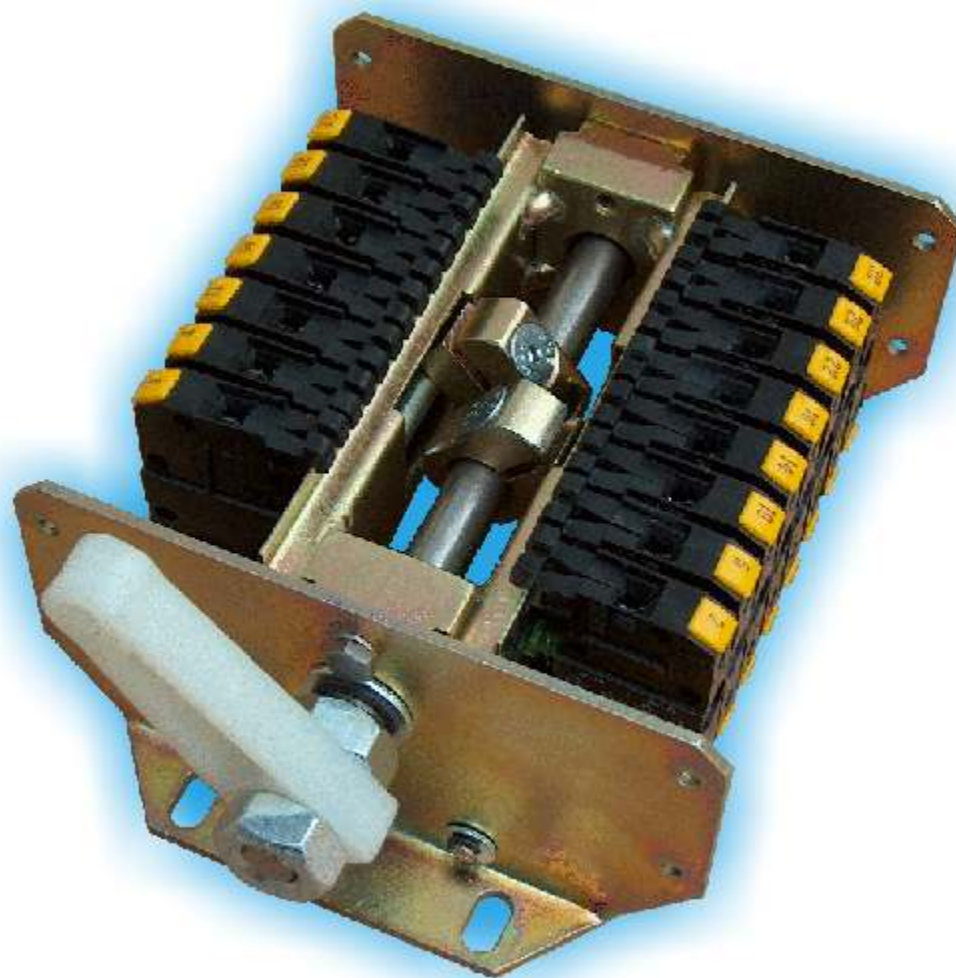

ISO 9001: 2000

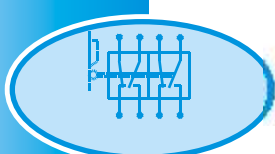
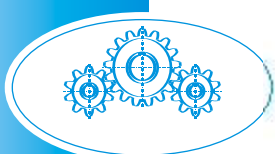
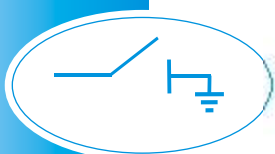
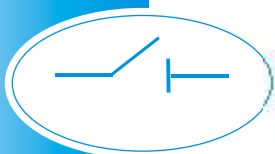
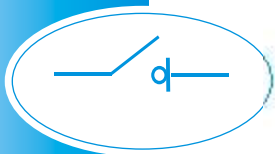
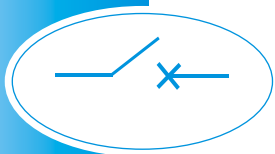

**LP-1**

06.01.01.RU

1.

2.

- 
- 
- 
- 
- 

3.

LP-1	
LP-1	1

1. : LP-1-1. OW-24.

4.

- 
- 

5.

		500B	
$I_u = I_{th}$		10 A	
		AC-15	DC-13
		220B - 2,6A	24B - 4A
		380B - 1,6A	110B - 1A
		500B - 1,6A	220B - 0.25A
:			
•		0,2	
•		1	80BA
•		1	10
		-5<>+50°C	
:			
•		$2 \times 1 <> 1,25^2$	
•		$2 \times 0.75 <> 1,5^2$	

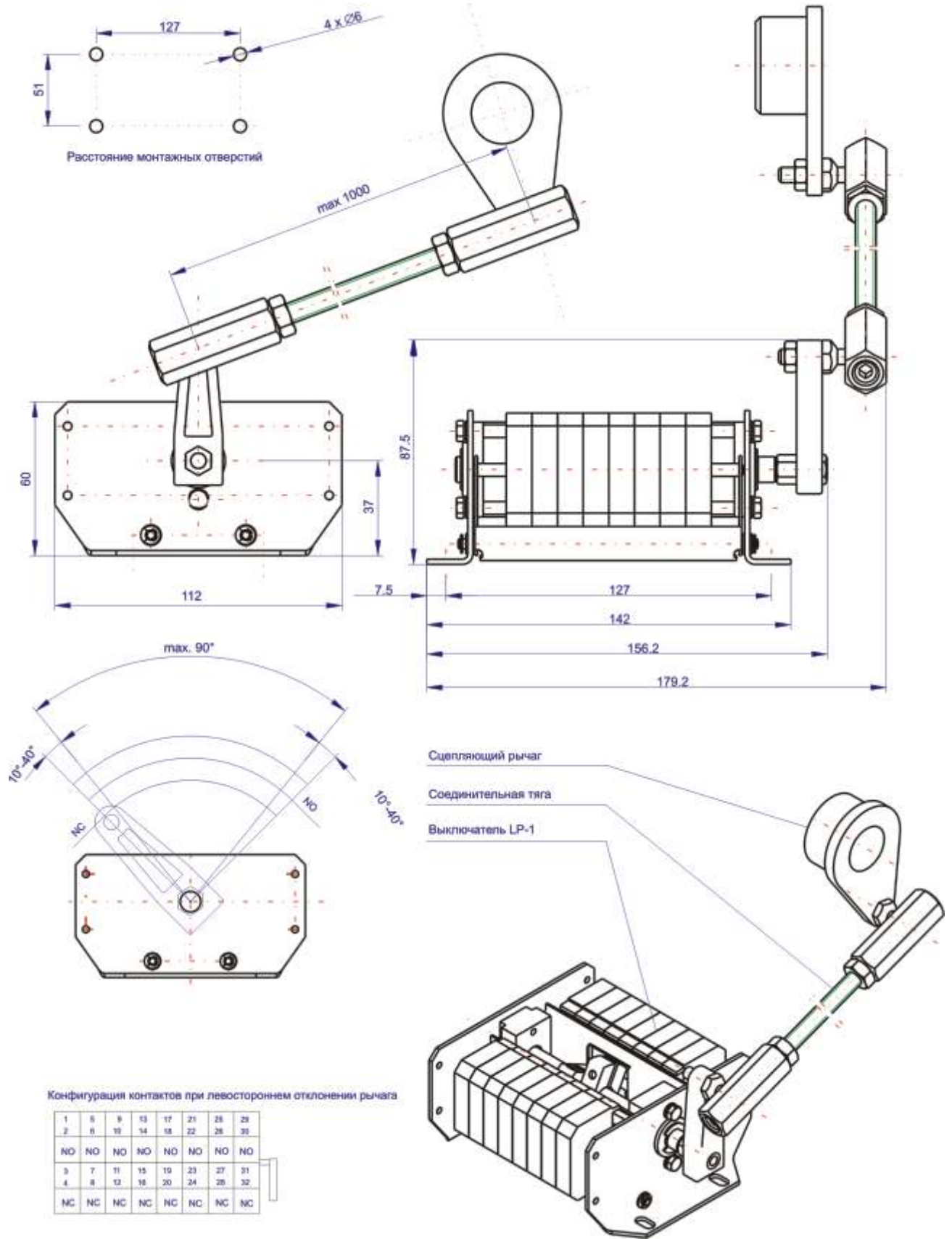

---

**Zakład Wytwórczy Aparatów Elektrycznych Sp. z o.o.**  
ul. Gdańska 60; 84-300 Lębork  
Tel.: +48 59 86-336-15; Fax: +48 59 86-333-86  
e-mail: [zvae@zvae.com.pl](mailto:zvae@zvae.com.pl)  
[www.zvae.com.pl](http://www.zvae.com.pl)

