

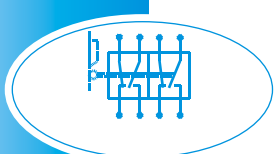

ISO 9001: 2000

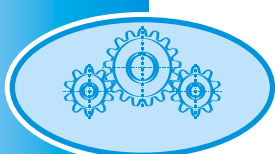
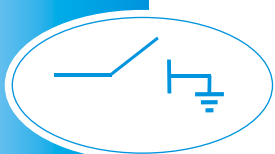
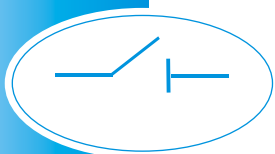
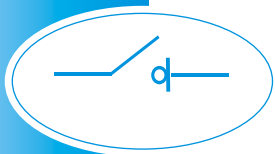
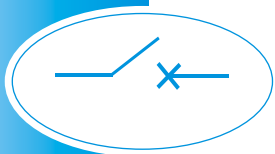

**NSO80**

05.07.02.RU



6.

N.	
1.	3x 400 VAC /4,5 A 220 VDC / 4 A 110 VDC / 10 A
	400 VAC 220 VDC 110 VDC
	220 VDC 220 VAC 110 VDC 110 VAC
	230 VAC 220 VDC
	220 VDC 110 VDC
2.	750 W 500 W
	7 W
	25 W
	7 W
3.	500 Nm 800 Nm
4.	. 8 s
5.	. 100
6.	192° ± 2°
7.	AC-15;V; 2,5 A DC-13; 220 V; 0,25 A
8.	4 mm <sup>2</sup>
9.	IP 54
10.	. 56 kg
11.	2000

7.

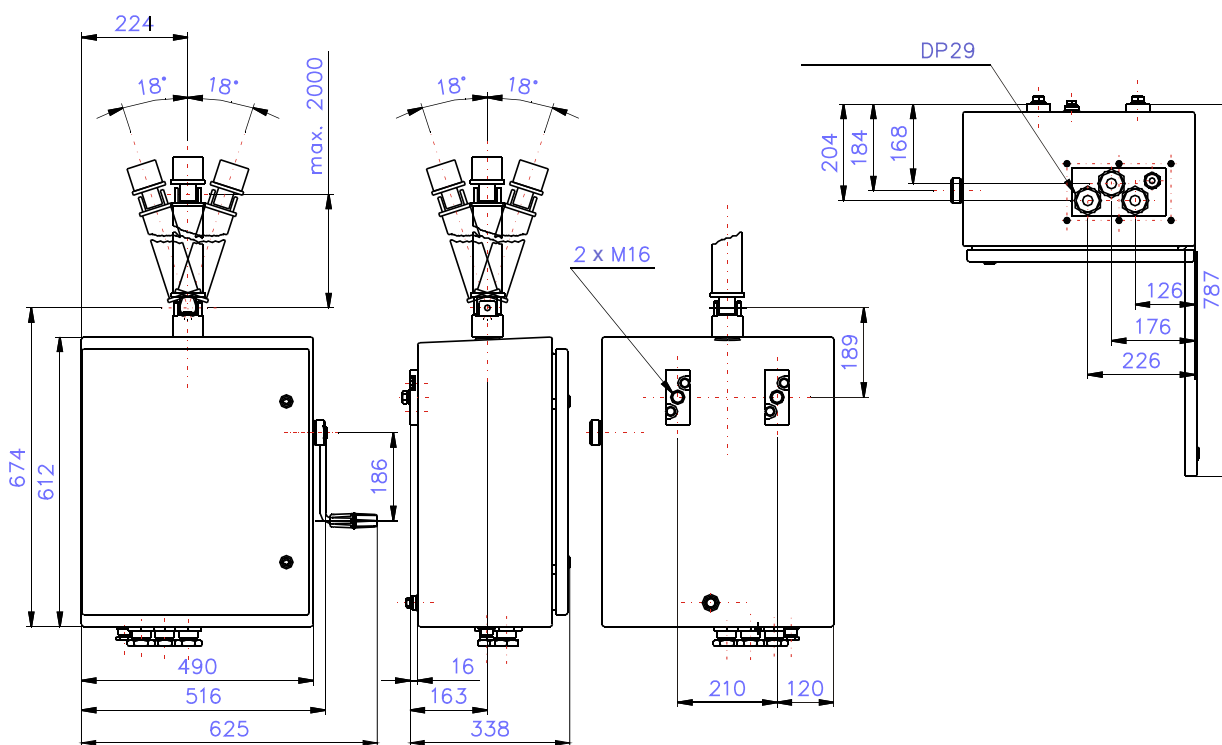

- 1.
2. 1,5 %

